

2

1

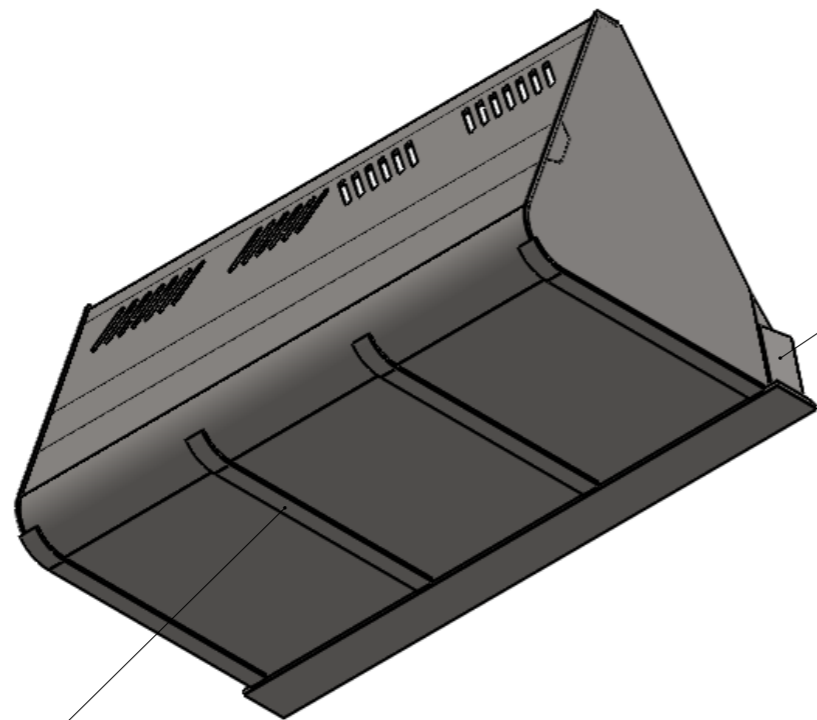

4

3

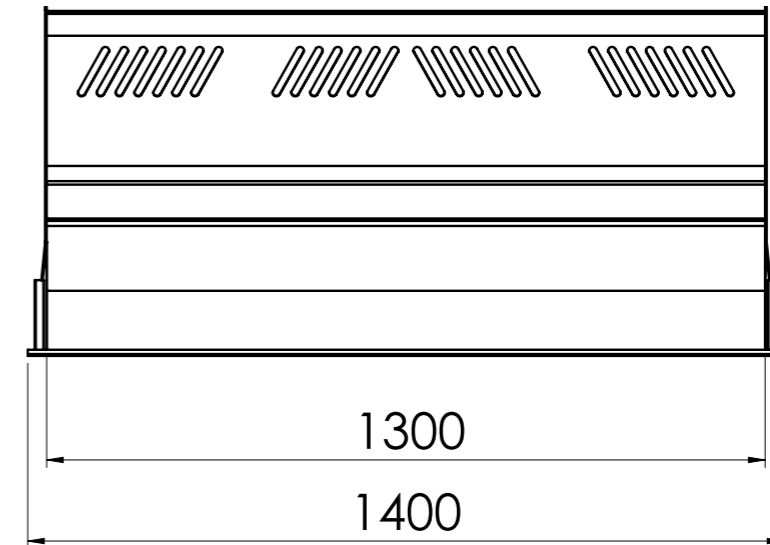
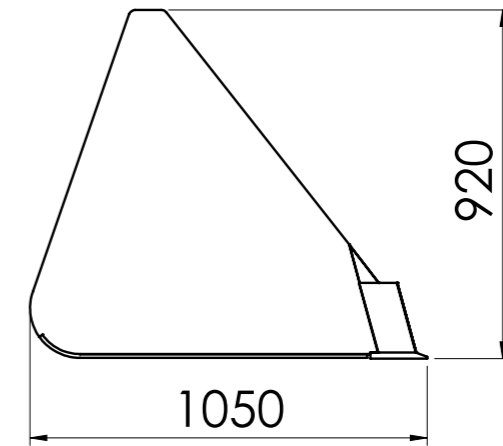

4	Bottom bar	S355	10 mm
3	Side member	HB 500	101x21/11x610 mm
2	Bottom plate	S355	4 mm
1	Front edge	HB 500	16x150x1400
NO.	TITLE	MATERIAL	DESCRIPTION

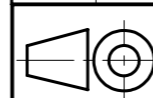

Volume 800 L

Mass 180 kg

Scale

Drawn Teet Toming

Name

Checked

LMB490/1400

Approved

PTC

Sheet
1 of 1

Date
27.04.2015